

Video-Türsprechanlage TC:Bus für 1 Eingang mit Videoverteiler

Strang 1

Innensprechstellen/Rufeinheit

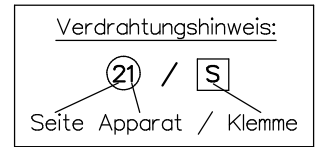
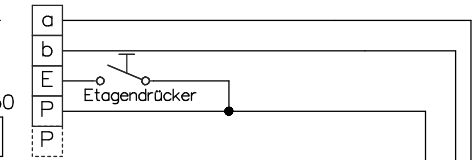
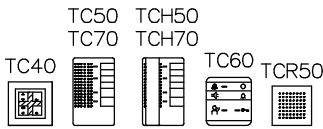

Video-Innensprechstellen

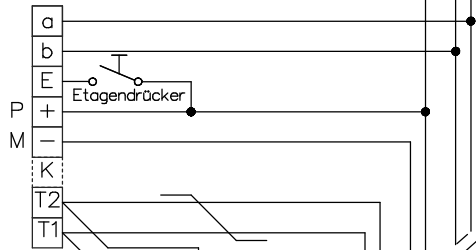
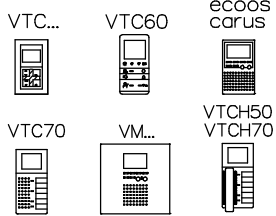

weitere Monitore abgeschlufft

Letzten Monitor mit 100Ω abschliessen

Video-Innensprechstellen

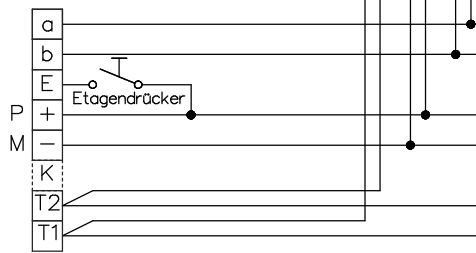
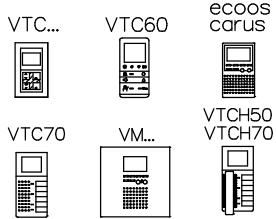

21/14
21/15
21/16
21/17
21/18
21/19

Strang 2

Letzten Monitor mit 100Ω abschliessen

Video-Innensprechstellen

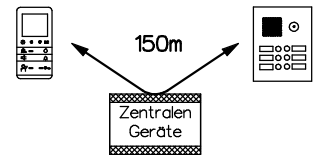
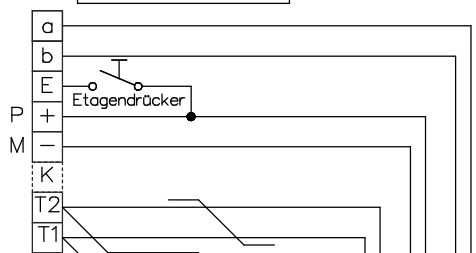
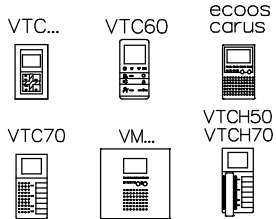

Beiblatt zu Schema TC:Bus unbedingt beachten!

Installationshinweise:

Es ist nur Kabel mit paarverdrillten Draht-Ø 0.8mm zulässig! (z.B. G51)

Maximale Leitungslänge pro Buslinie bei Draht-Ø 0.8mm bis 150m

Video-Tischsprechstellen

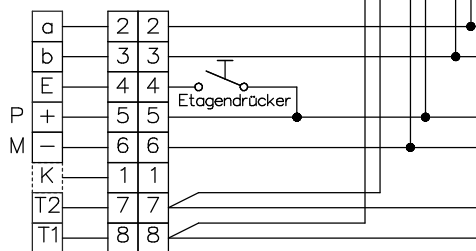
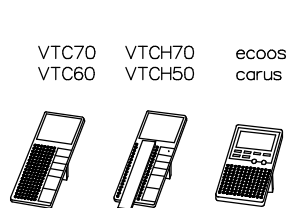

21/20
21/21
21/22
21/23
21/24
21/25

Stecker RJ45/8pol. Anschlussdose RJ45/8pol.



René Koch AG
Seestrasse 241, 8804 Au/Wädenswil
044 782 6000
www.kochag.ch, info@kochag.ch

ISO 9001

Kunde

Kom.

Vg.

Index F

CAD 01331/012

Schema TCV254/VV22/VTC/VK

Gez. 21.12.21 CN

Geänd. 12.01.24 CN

Geänd.

Blatt 1/2

Video-Türsprechanlage TC:Bus für 1 Eingang mit Videoverteiler

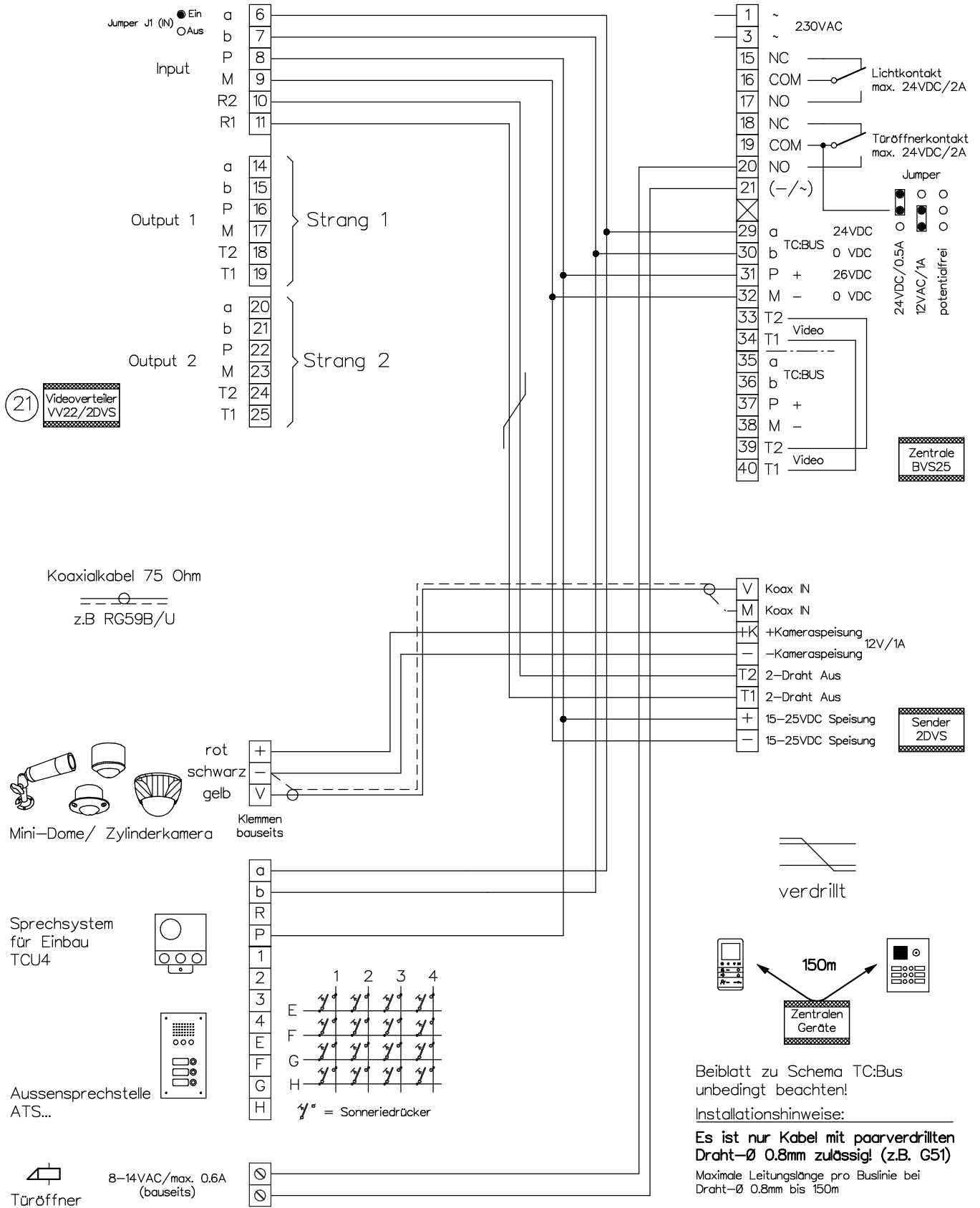

KO(H)

René Koch AG
Seestrasse 241, 8804 Au/Wädenswil
044 782 6000
www.kochag.ch, info@kochag.ch

ISO 9001

Kunde

Kom.

Vg.

Index F

CAD 01331/014

Schema TCV254/VV22/VTC/VK

Gez. 21.12.21 CN

Geänd. 12.01.24 CN

Geänd.

Blatt 2/2