

Video-Türsprechanlage TC:Bus für 1 Eingang mit Infoterminal und Videoverteiler

Strang 1

Innensprechstellen/Rufeinheit

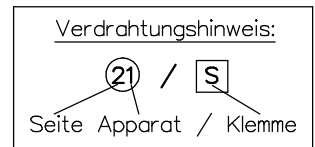
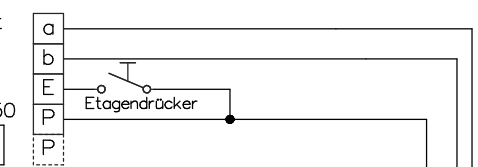
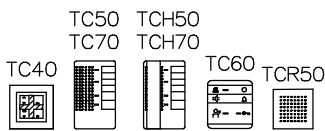

Video-Innensprechstellen

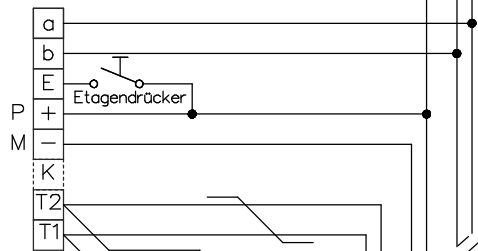
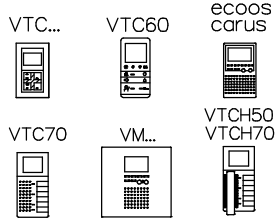

Letzten Monitor mit 100Ω abschliessen

weitere Monitore abgeschaltet

Video-Innensprechstellen

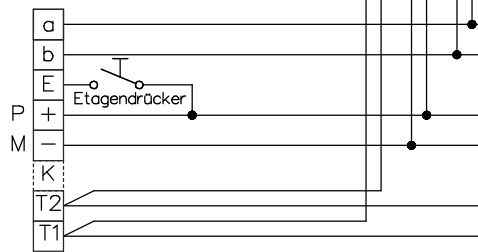
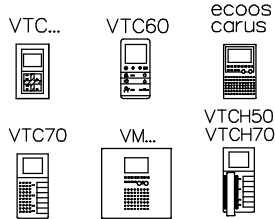

31/18
31/19
31/20
31/21
31/22
31/23

Strang 2

Video-Innensprechstellen

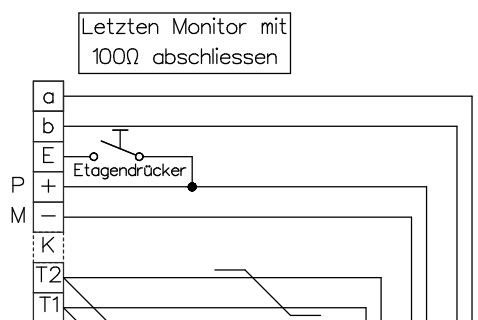
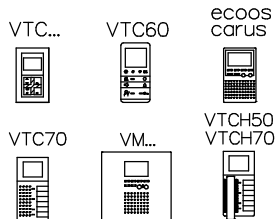

Letzten Monitor mit 100Ω abschliessen

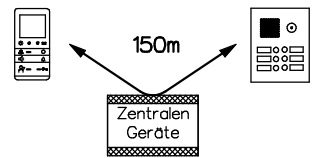

Beiblatt zu Schema TC:Bus unbedingt beachten!

Installationshinweise:
Es ist nur Kabel mit paarverdrillten Draht-Ø 0.8mm zulässig! (z.B. G51)

Maximale Leitungslänge pro Buslinie bei Draht-Ø 0.8mm bis 150m

Video-Tischsprechstellen

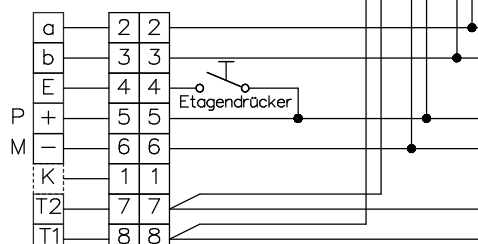
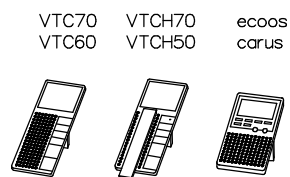

31/24
31/25
31/26
31/27
31/28
31/29

Stecker RJ45/8pol. Anschlussdose RJ45/8pol.



René Koch AG
Seestr. 241, 8804 Au/Wädenswil
044 782 6000
www.kochag.ch, info@kochag.ch

ISO 9001

Kunde			
Kom.		Vg.	
Index	F	CAD 01331/140	Schema TCV254/VV24/VTPAS
Gez.	21.12.21 CN	Geänd. 12.01.24 CN	Geänd. Blatt 1/3

Video-Türsprechanlage TC:Bus für 1 Eingang mit Infoterminal und Videoverteiler

Strang 3

Innensprechstellen/Rufeinheit

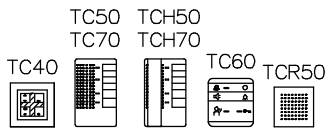

Video-Innensprechstellen

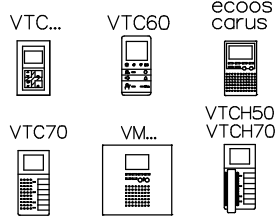

Video-Innensprechstellen

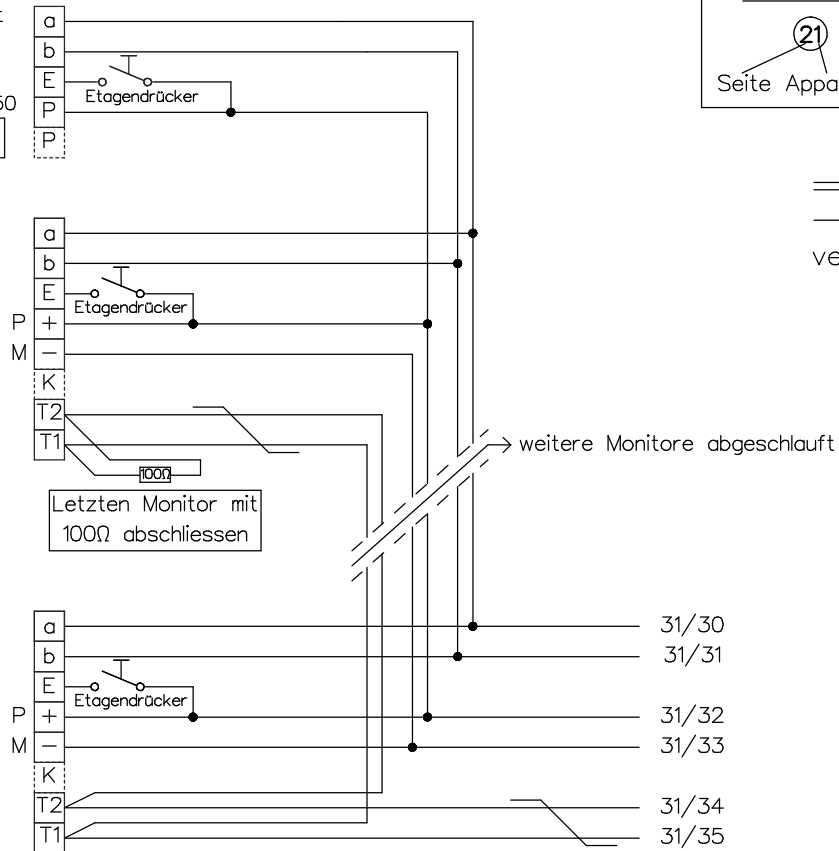
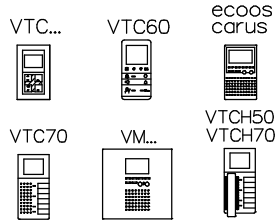

Strang 4

Video-Innensprechstellen

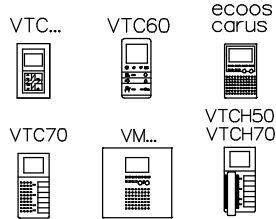

Video-Tischsprechstellen

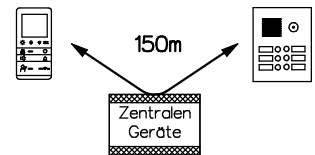
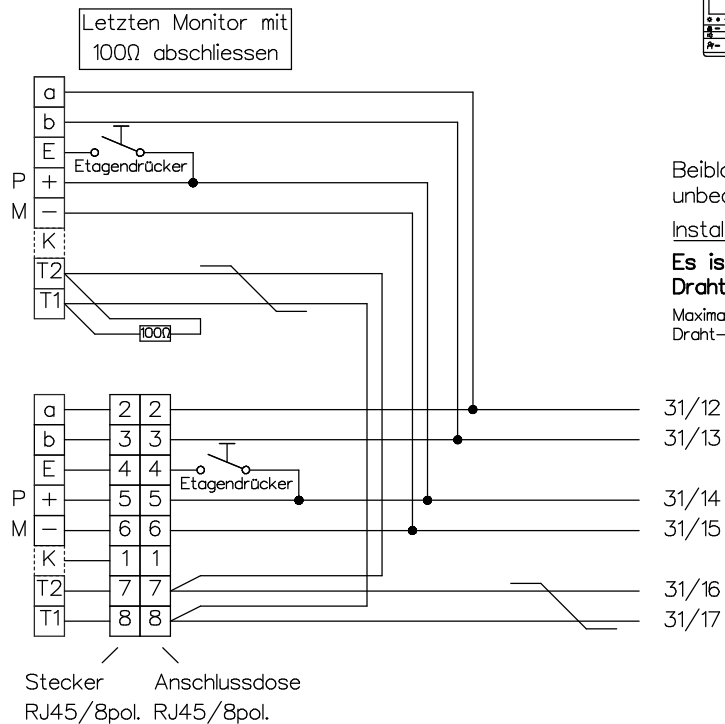
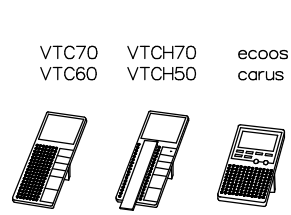

Beiblatt zu Schema TC:Bus unbedingt beachten!

Installationshinweise:

Es ist nur Kabel mit paarverdrillten Draht-Ø 0.8mm zulässig! (z.B. G51)

Maximale Leitungslänge pro Buslinie bei Draht-Ø 0.8mm bis 150m



René Koch AG
 Seestrasse 241, 8804 Au/Wädenswil
 044 782 6000
 www.kochag.ch, info@kochag.ch

ISO 9001

Kunde		Vg.	
Kom.			
Index F	CAD 01331/142	Schema TCV254/VV24/VTPAS	
Gez. 21.12.21 CN	Geänd. 12.01.24 CN	Geänd.	Blatt 2/3

Video-Türsprechanlage TC:Bus für 1 Eingang mit Infoterminal und Videoverteiler

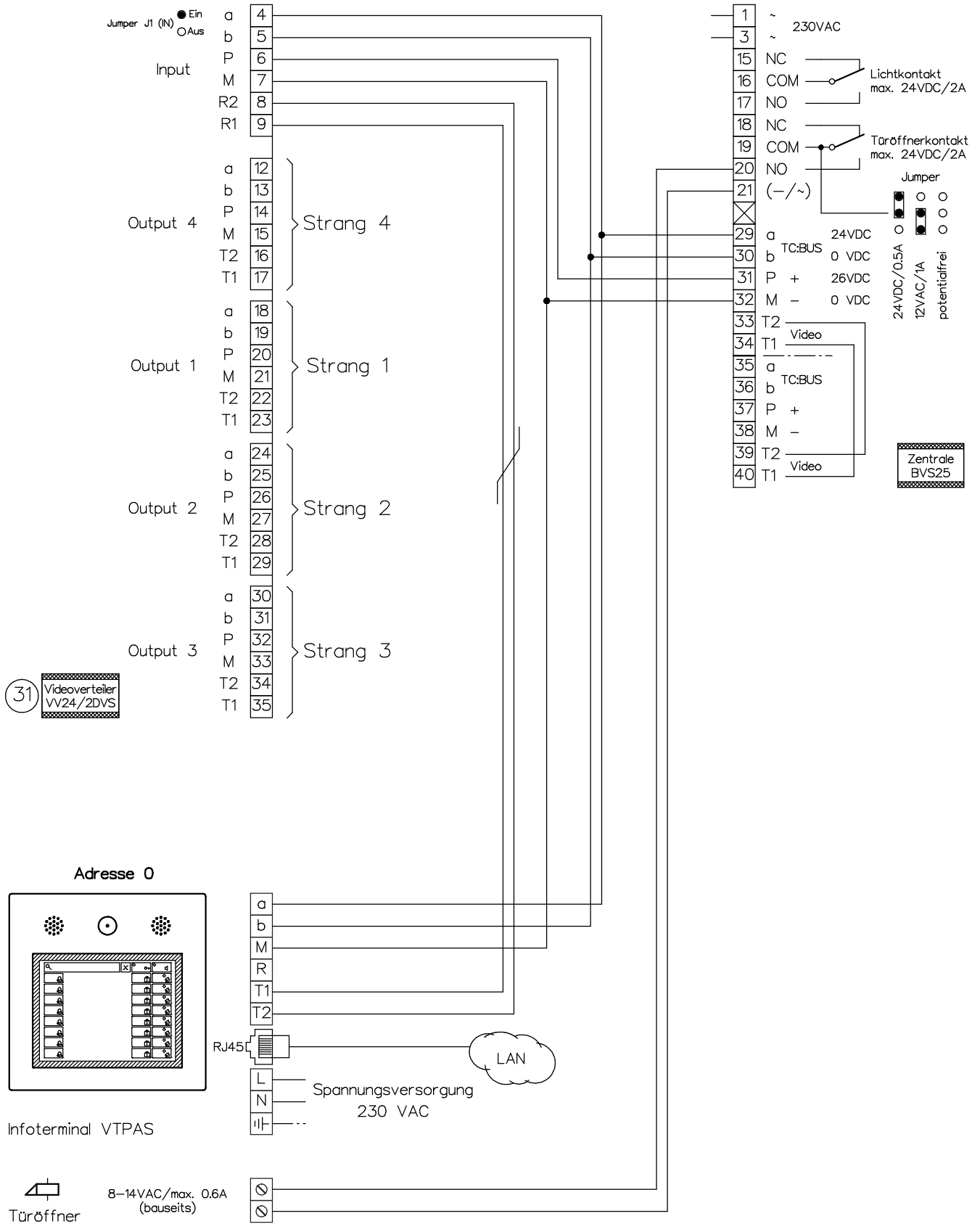

Kunde			
Kom.		Vg.	
Index	F	CAD 01331/160	Schema TCV254/VV24/VTPAS
Gez.	21.12.21 CN	Geänd. 12.01.24 CN	Geänd.
			Blatt 3/3