

# Zutrittssystem s/xLine für fünf Fingerprints

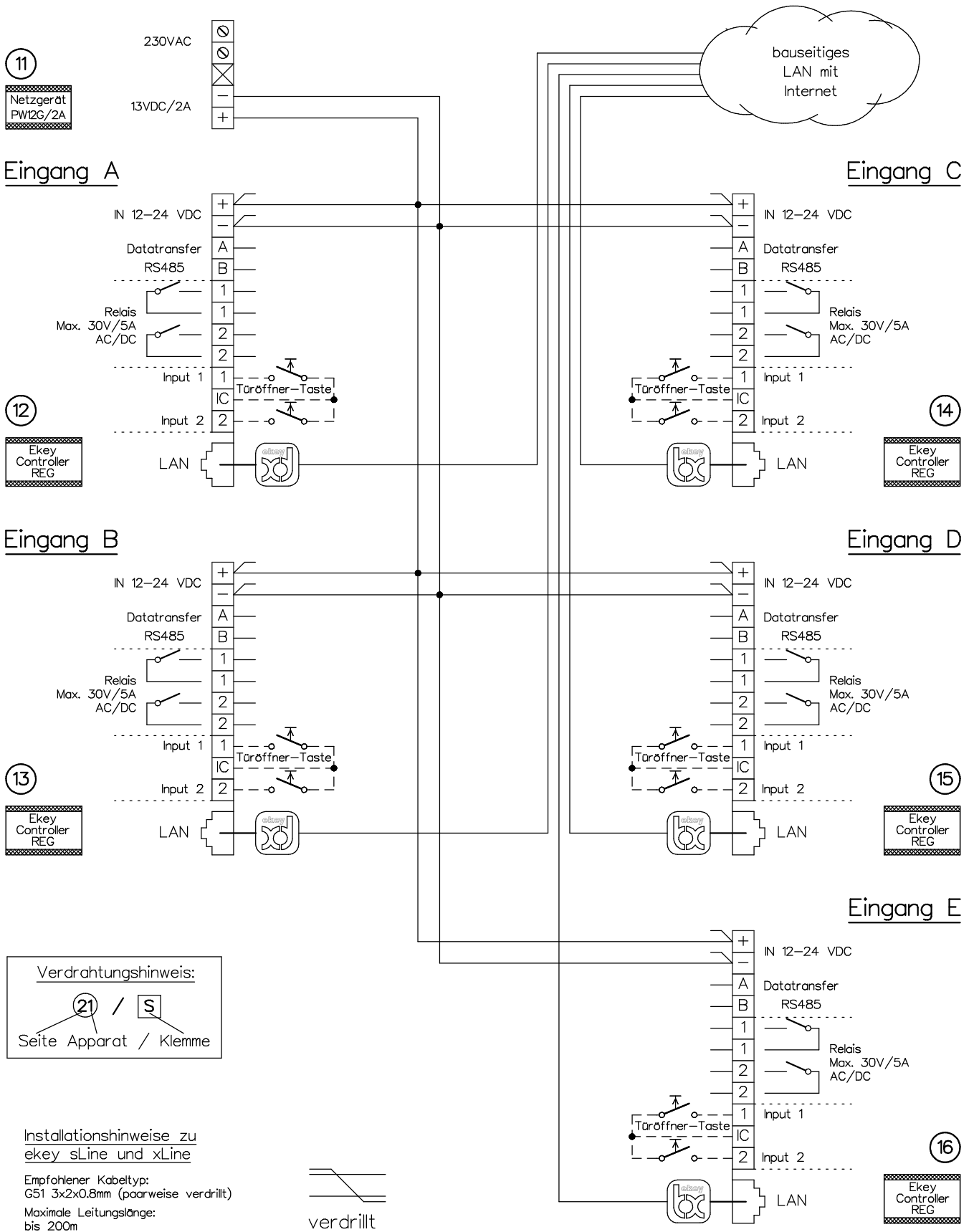

René Koch AG  
Seestrasse 241, 8804 Au/Wädenswil  
044 782 6000  
www.kochag.ch, info@kochag.ch

ISO 9001

Kunde			
Kom.		Vg.	
Index F	CAD 01280/042	Schema ekey/5DRM2	
Gez. 25.04.23 DB	Geänd.	Geänd.	Blatt 1/2

# Zutrittssystem ekey s/xLine für fünf Fingerprints

## Eingang A

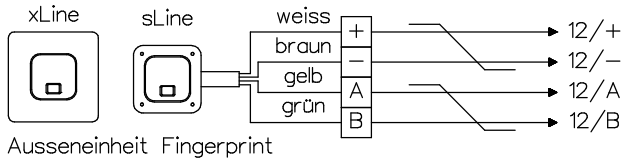

## Eingang C

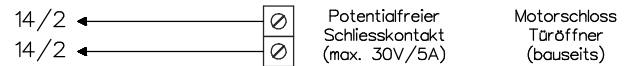
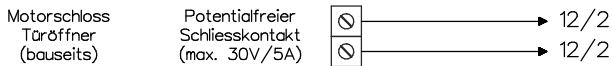
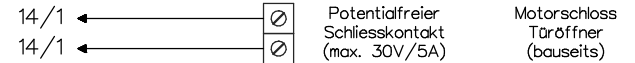
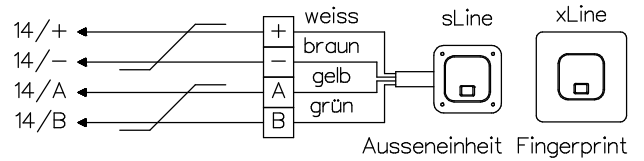

## Eingang B

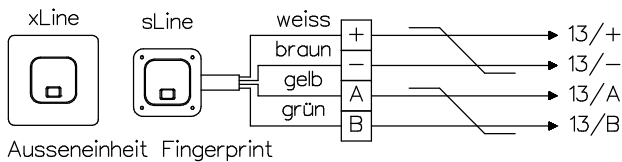

## Eingang D

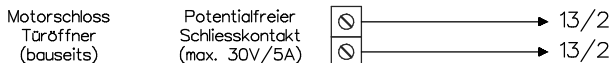
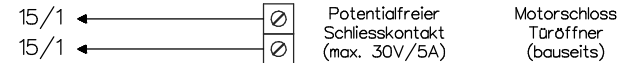
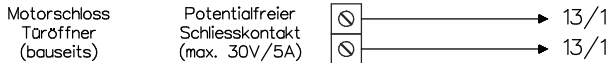
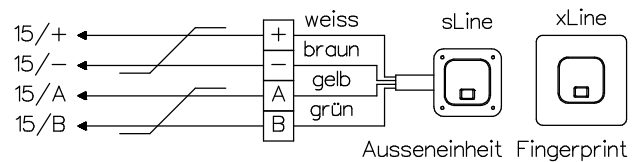

## Eingang E

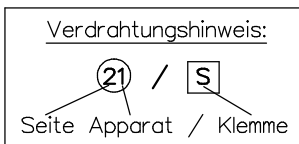
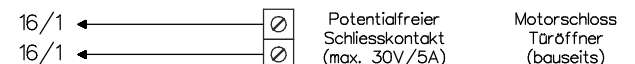
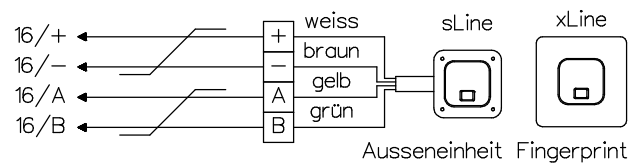

### Installationshinweise zu ekey sLine und xLine

Empfohlener Kabeltyp:  
G51 3x2x0.8mm (paarweise verdreht)

Maximale Leitungslänge:  
bis 200m

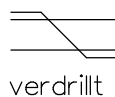

<p>René Koch AG Seestrasse 241, 8804 Au/Wädenswil 044 782 6000 www.kochag.ch, info@kochag.ch</p> <p>ISO 9001</p>	Kunde			
	Kom.			Vg.
	Index F	CAD 01280/044	Schema ekey/5DRM2	
	Gez. 25.04.23 DB	Geänd.	Geänd.	Blatt 2/2