

Contrôle d'accès par identification d'empreintes digitales ekey s/xLine avec 5 lecteur

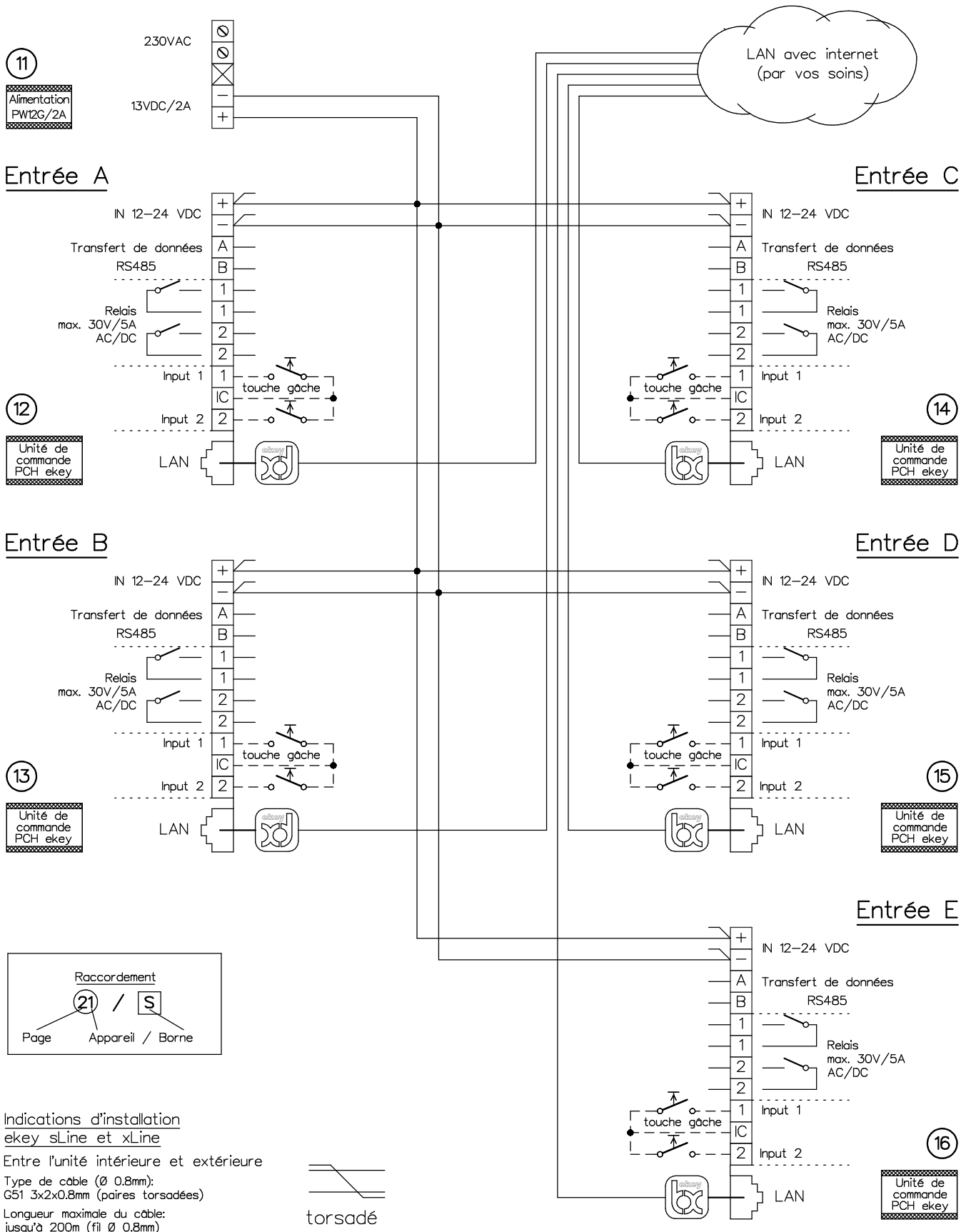

Client			
Réf		Vg.	
Index F	CAD 01280/042	Schéma ekey/5DRM2 f	
Gez. 25.04.23 DB	Geänd.	Geänd.	Blatt 1/2

Contrôle d'accès par identification d'empreintes digitales ekey s/xLine avec 5 lecteur

Entrée A

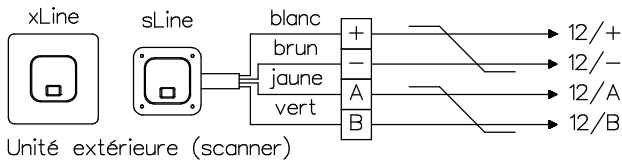

Entrée C

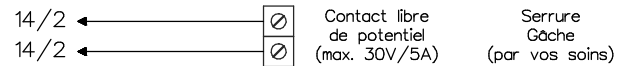
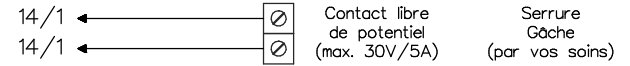
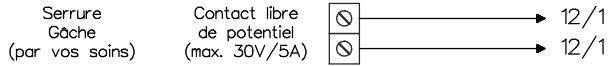
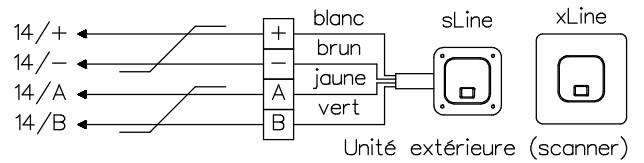

Entrée B

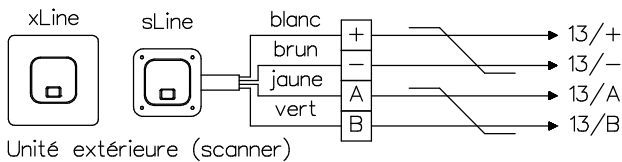

Entrée D

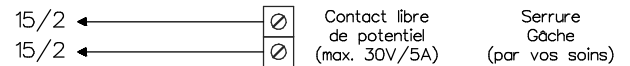
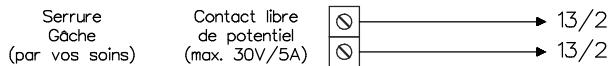
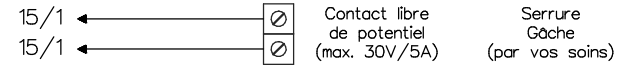
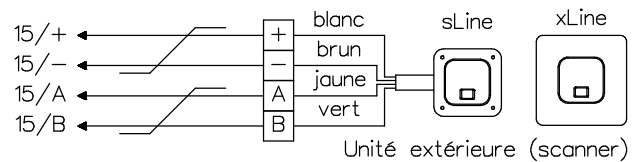

Entrée E

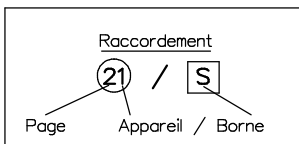
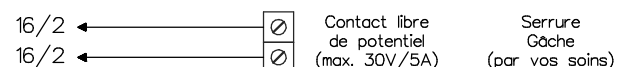
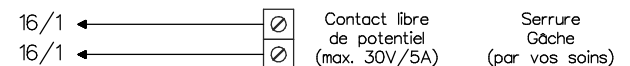
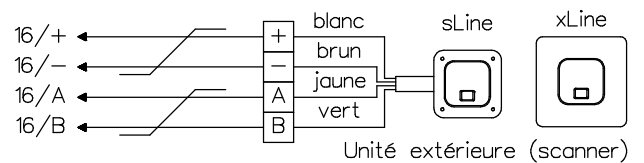

Indications d'installation

ekey sLine et xLine

Entre l'unité intérieure et extérieure

Type de câble (Ø 0.8mm):
G51 3x2x0.8mm (paires torsadées)

Longueur maximale du câble:
jusqu'à 200m (fil Ø 0.8mm)

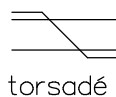

KO(H)

René Koch AG
Seestrasse 241, 8804 Au/Wädenswil
044 782 6000
www.kochag.ch, info@kochag.ch

ISO 9001

Client				
Réf			Vg.	
Index	F	CAD	01280/044	Schéma ekey/5DRM2 f
Gez.	25.04.23 DB	Geänd.	Geänd.	Blatt 2/2